

ELEGANCE,  
STYLING,  
CRAFTSMANSHIP,  
ITALIAN  
LIFESTYLE



**CTS**  
ITALIAN SOFAS

ELEGANCE,  
STYLING,  
CRAFTSMANSHIP,  
ITALIAN  
LIFESTYLE

**CTS**  
ITALIAN SOFAS







## WE ARE UNIQUE

CON QUESTA PUBBLICAZIONE CTS ESPONE LA SUA VISIONE DEGLI INTERNI PER LA CASA DI OGGI, UNA VISIONE INTIMA PER LUOGHI SPECIALI CON UN'ATMOSFERA DI PIACERE EMOTIVO, UN POSTO DOVE RILASSARSI E INTRATTENERE GLI OSPITI CIRCONDATI DALL'ELEGANZA.

CTS VUOLE COMUNICARE UN'ATMOSFERA PARTICOLARE, VESTIRE OGNI GIORNO GLI SPAZI DEL VIVERE CON LA BELLEZZA, CON I DIVANI DELLE SUE COLLEZIONI DOVE OGNI DETTAGLIO È METICOLOSAMENTE CONCEPITO PER ESPRIMERE LA SUA IDEA DEL LUSO IDEALE.

CTS UNVEIES ITS INTERIORS VISION FOR TODAY'S HOME, AN INTIMATE VISION FOR SPECIAL PLACES WITH EMOTIONAL PLEASURE. A PLACE TO RELAX THEMSELVES AND WHERE TO ENTERTAIN GUESTS, SURROUNDED BY ELEGANCE.

CTS WANTS TO EVOKE ONES DREAMS, WANTS TO TAILOR EVERYDAY LIVING SPACES WITH BEAUTY, AND WITH ITS PRODUCTS , WHERE EVERY DETAIL IS THINKE TO EXPRESS ITS LUXURY CONCEPT TO ITS GUEST.

**CTS**  
ITALIAN SOFAS





INDEX

SOFA

KANT 01 PAG.10



KANT 02 PAG.14



SOFA

KANT 03 PAG.18



KANT 04 PAG.22



SOFA

KANT 05 PAG.26



INDEX

SOFA

BAGUTTA 01 PAG.32



BAGUTTA 02 PAG.36



SOFA

BAGUTTA 03 PAG.40



BAGUTTA 04 PAG.44





ARMCHAIR

NAVONA PAG.48

MARGOT



ARMCHAIR

GUEST

JACK



SMALL TABLES

KANT PAG.50

KANT



SMALL TABLES

CHARME

TAPE



POUFF

BRERA

DOMINO



POUFF

TRESOR





# KANT 01

## SOFA

Design Marconato&Zappa  
Cm. 372x220x80 h.

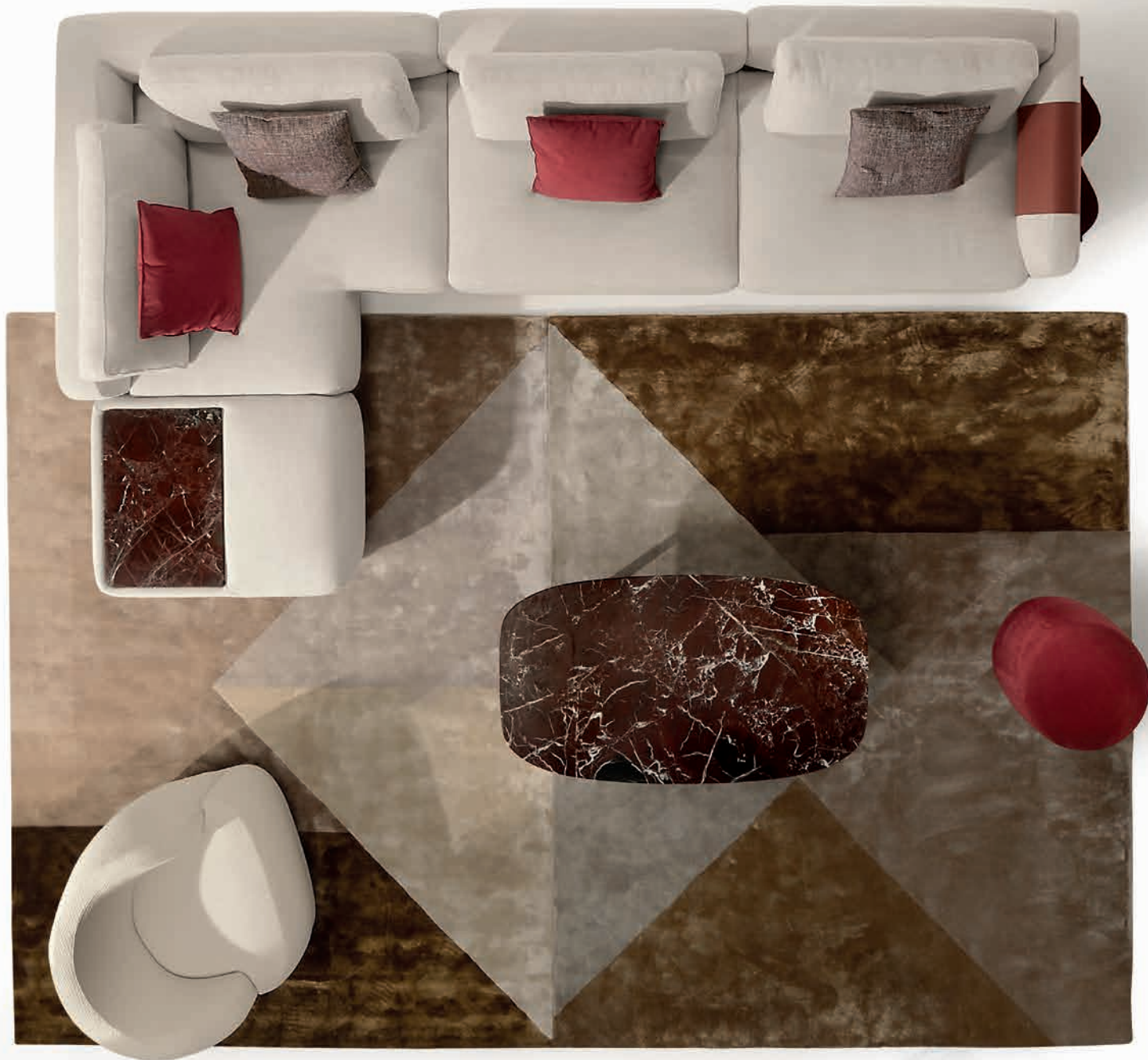

L'ESTETICA SENZA TEMPO DI KANT SI CONCENTRA SU LINEE SEMPLICI E PROPORZIONI PERFETTE, ARRICCHITE DA UN VALORE AGGIUNTO COME IL PIANO IN MARMO POSTO SUL POUFF TERMINALE, UTILE E SERVIZIEVOLE ACCESSORIO.

KANT TIMELESS STYLE FOCUSES ON SIMPLE LINES AND PERFECT PROPORTIONS, ENRICHED WITH LUXURIOUS MATERIALS LIKE MARBLE TOPS.





# KANT 01

SOFA

Design Marconato&Zappa  
Cm. 372x220x80 h.

“IL DESIGN NON È SOLO L'ASPETTO  
E LA PERCEZIONE.  
IL DESIGN È COME FUNZIONA.”

“DESIGN IS A FUNNY WORD. SOME PEOPLE THINK  
DESIGN MEANS HOW IT LOOKS. BUT OF COURSE,  
IF YOU DIG DEEPER, IT'S REALLY HOW IT WORKS.”

(Steve Jobs)

DIVANO KANT, POLTRONA NAVONA, TAVOLINO CHARME, POUFF DOMINO.  
KANT SOFA, NAVONA ARMCHAIR, CHARME COFFEE TABLES, DOMINO POUF.



# KANT 02

## SOFA

Design Marconato&Zappa  
Cm. 354x175x80 h.



LA RICERCA DI UN COMFORT SOFISTICATO SI  
TRASFORMA NELLA CREAZIONE DI UN'AMBIENTAZIONE  
DOMESTICA TOTALE, CHE UTILIZZA UN LINGUAGGIO  
PROGETTUALE MODERNO, RAZIONALE ED ELEGANTE.

THE SEARCH FOR A SOPHISTICATED COMFORT BECOMES  
A VERY RATIONAL, MODERN AND ELEGANT HOME SETTING.





# KANT 02

SOFA

Design Marconato&Zappa  
Cm. 354x175x80 h.

DIVANO KANT, POLTRONA NAVONA, TAVOLINO KANT.  
KANT SOFA, NAVONA ARMCHAIR, KANT COFFEE TABLE.

INTERPRETAZIONI CONTEMPORANEE PER  
ELEMENTI IMBOTTITI INNOVATIVI,  
PER UNA MODULARITÀ APERTA ALLA CONVIVIALITÀ.

CONTEMPORARY INTERPRETATION OF INNOVATIVE  
UPHOLSTERY FURNITURE FOR OPEN CONVIVIALITY.





# KANT 03

SOFA

Design Marconato&Zappa  
Cm. 324x100x80 h.



UN'ESTETICA IMPECCABILE SPOSA SOLUZIONI DI INTERIOR  
DESIGN INNOVATIVE COME LE BORSE PORTA RIVISTE  
REALIZZATE IN CUIO, CON CUCITURE ESEGUITE A MANO.

AN IMPECCABLE STYLE JOINS INNOVATIVE INTERIOR DESIGN  
SOLUTIONS AS CUIR BAG RACK WITH HANDMADE STITCHINGS.





# KANT 03

SOFA

Design Marconato&Zappa  
Cm. 324x100x80 h.

“IL DESIGN È L'INTELLIGENZA  
RESA VISIBILE.”

“DESIGN IS INTELLIGENCE MADE VISIBLE.”

(Alina Wheeler)

DIVANO KANT, POLTRONA NAVONA, TAVOLINO KANT, POUFF DOMINO.  
KANT SOFA, NAVONA ARMCHAIR, KANT COFFEE TABLE, DOMINO POUF



# KANT 04

## SOFA

Design Marconato&Zappa  
Cm. 244x100x80 h.





# KANT 04

## SOFA

Design Marconato&Zappa  
Cm. 244x100x80 h.



KANT È VALORIZZATO DA FORME SENZA TEMPO E DA UN'AMPIA MODULARITÀ CONTEMPORANEA. VOLUMI IMPORTANTI PER UN DIVANO CAPACE DI REGALARE IL COMFORT DESIDERATO.

KANT HAS TIMELESS SHAPES AND A BROAD MODULARITY. IMPORTANT VOLUMES FOR A SOFA THAT GIVES THE DESIRED COMFORT.

DIVANO KANT, POLTRONA JACK, TAVOLINO CHARME.  
KANT SOFA, JACK ARMCHAIR, CHARME COFFEE TABLE.



# KANT 05

## SOFA

Design Marconato&Zappa  
Cm. 412x100x80 h.





# KANT 05

SOFA

Design: *Antonio Zappa*  
Crea: *Antonio Zappa*

ELEMENTI COMFORT CON GEOMETRIE PULITE,  
ELEGANZA E RELAX: KANT ESALTA LA  
CAPACITÀ SARTORIALE DELLE COLLEZIONI CTS SALOTTI.

CLEAN, ELEGANT AND RELAXING SHAPES:  
KANT HIGHLIGHTS CTS TAILOR MADE SOLUTIONS.

DIVANO KANT, POLTRONA NAVONA, TAVOLINI TAPE.  
KANT SOFA, NAVONA ARMCHAIR, TAPE COFFEE TABLES.







# BAGUTTA 01

## SOFA

Design Marconato&Zappa  
Cm. 410x380x71 h.



CAPACITÀ SARTORIALI, GRANDI COMPETENZE E DESIGN SEDUCENTE: IL DIVANO BAGUTTA HA QUESTE PECULIARITÀ CHE NE SOTTOLINEANO L'ARTIGIANALITÀ DELLA COLLEZIONE. INTERESSANTE IL TAVOLINO IN MARMO POSTO AL CENTRO DELLA COMPOSIZIONE.

TAILOR MADE SOLUTIONS, HIGH SKILLS AND SEDUCTIVE DESIGN; BAGUTTA SOFA HAS THESE FEATURES THAT UNDERLINE THE COLLECTION CRAFTMANSHIP. EXCITING THE MARBLE SMALL TABLE AT COMPOSITION CENTER.





# BAGUTTA 01

SOFA

Design Marconato&Zappa  
Cm. 410x380x71 h.



DIVANO BAGUTTA, POLTRONA GUEST, TAVOLINI TAPE.  
BAGUTTA SOFA, GUEST ARMCHAIR, TAPE COFFEE TABLES.



# BAGUTTA 02

SOFA

Design Marconato&Zappa  
Cm. 325x105x71 h.





# BAGUTTA 02

SOFA

Design Marconato&Zappa  
Cm. 325x105x71 h.

“LA MODA PASSA,  
LO STILE RESTA.”

“FASHION CHANGES, BUT STYLE ENDURES.”

(Coco Chanel)



# BAGUTTA 03

SOFA

Design Marconato&Zappa  
Cm. 370x150x71 h.



BAGUTTA È ESALTATO DALLE SUE LINEE E DALLE ROTONDITÀ CHE LO RENDONO UNICO NEL SUO GENERE; TUTTO PERFETTAMENTE INTEGRATO IN UN DIVANO DI GRANDE COMFORT DAL DESIGN PARTICOLARE.

BAGUTTA IS HIGHLIGHTED BY ITS CURVES AND SHAPES, THAT MAKE IT UNIQUE ; EVERYTHING IS PERFECTLY COMBINED IN A HIGH COMFORT SOFA WITH UNUSUAL STYLE.





# BAGUTTA 03

SOFA

Design Marconato&Zappa  
Cm. 370x150x71 h.



DIVANO BAGUTTA, POLTRONA MARGOT, TAVOLINO TAPE, POUFF TRESOR.  
BAGUTTA SOFA, MARGOT ARMCHAIR, TAPE COFFEE TABLE, TRESOR POUF.



# BAGUTTA 04

SOFA

Design Marconato&Zappa  
Cm. 240x105x71 h.





# BAGUTTA 04

SOFA

Design Marconato&Zappa  
Cm. 240x105x71 h.



UN MIRABILE ESEMPIO DI PERFEZIONE FORMALE. IL DIVANO BAGUTTA: ALLE PROPORZIONI DI UN DESIGN CONTEMPORANEO ABBINA CUCITURE E LAVORAZIONI MANUALI DI PREGIO PER UN RISULTATO DI GRANDE FASCINO.

BAGUTTA SOFA IS AN AMAZING EXAMPLE OF FORMAL PERFECTION: CONTEMPORARY DESIGN PROPORTIONS FOR A SOFA THAT COMBINES HANDMADE STITCHES AND VALUABLE MANUAL WORK. THE RESULT IS OF GREAT CHARM.

DIVANO BAGUTTA, POLTRONA JACK, POUFF DOMINO, POUFF BRERA.  
BAGUTTA SOFA, JACK ARMCHAIR, DOMINO POUF, BRERA POUF.



# NAVONA

## ARMCHAIR

Design Marconato&Zappa  
Cm. 88x86x70 h.



“LA GRAZIA CIRCONDA  
L'ELEGANZA E LA RIVESTE.”

“GRACE SURROUNDS ELEGANCE AND COVERS IT.”

(Joseph Joubert)

LA LINEA DOLCEMENTE CURVATA DELLA POLTRONA NAVONA È  
UN INVITO AL RELAX ASSOLUTO; UN DESIGN INNOVATIVO PER UN  
PRODOTTO DA ABBINARE AI DIVANI DELLE COLLEZIONI CTS.

NAVONA ARMCHAIR GENTLY CURVED STYLE  
IS A TEMPTATION TO UNLIMITED REST; AN INNOVATIVE  
STYLE ARMCHAIR TO MATCH CTS SOFA COLLECTIONS.



# KANT

## COFFEE TABLE

Design Marconato&Zappa  
Cm. 70x140x30 h.



DETTAGLIO SUL PIANO DEL TAVOLINO IN MARMO  
CON STRUTTURA IMBOTTITA.

DETAIL OF THE UPHOSTERED SMALL TABLE MARBLE TOP.





KANT

SEDUTA

FIANCO DX

FIANCO SX

BAGUTTA



# KANT

Design Marconato&Zappa

**Struttura:** realizzata in legno di massello e multistrato. Il molleggio è ottenuto con cinghie elastiche larghezza mm 90, rivestita in poliuretano espanso densità differenziata 25P e 40P e tela di cotone 150 gr. con vellutino.

**Imbottitura:** cuscini seduta in poliuretano espanso densità differenziata 35KN 30S rivestiti con fibra di dacron 150 gr. Cuscino schienale in Piumafill.

**Rivestimento:** tessuto completamente sfoderabile.

**Marmi per tavolino:** Emperador, Calacatta, Sahara Noir, Rosso Lepanto, Verde Guatemala, Bianco Carrara.

**Finiture:** piedini in abs nero.

**Frame:** made in fir wood and multi-ply panels. The support system is created using 90 mm wide interwoven elastic straps, covered in polyurethane differentiated densities 25P 40P and 150 gr. cotton cloth with velveteen.

**Padding:** seat cushions in polyurethane foam with differentiated density 35KN 30S and 150 gr. cotton cloth with velveteen. Back cushions in piumafill.

**Cover:** completely removable fabric.

**Marble for side table:** Emperador, Calacatta, Sahara Noir, Lepanto red, Guatemala green, Bianco Carrara.

**Finishes:** feet in black abs.

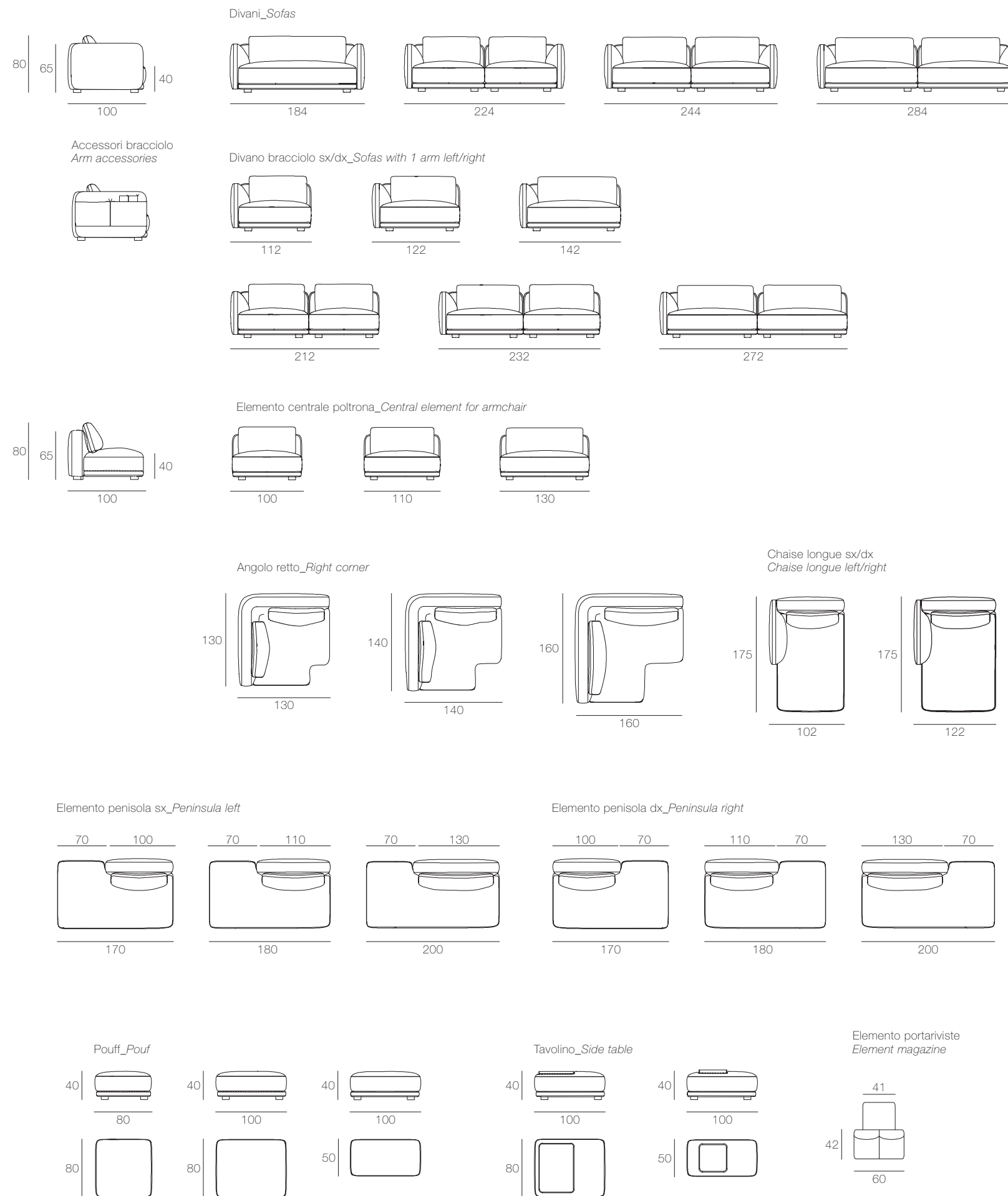

## VARIANTI PIANO IN MARMO MARBLE TOP OPTIONS

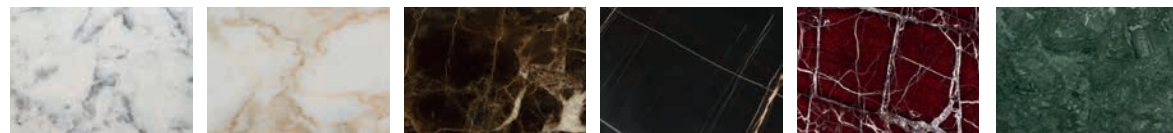

Bianco Carrara  
Carrara white

Calacatta  
Calacatta

Emperador  
Emperador

Sahara Noir  
Sahara noir

Rosso Lepanto  
Lepanto red

Verde Guatemala  
Guatemala green



# KANT

Design Marconato&Zappa

## Composizione pagina 12-13 / Layout page 12-13

Divano Kant: rivestimento art.1960/110, cat. EXTRALUX.  
 Cuscini decorativi art.4263/18, cat. H e art. 1900/05, cat. H.  
 Poltrona Navona: rivestimento art.1940/21, cat. pelle accoppiata.  
 Pouff Domino Ø50x43h: rivestimento art.4263/18, cat. H.  
 Tavolino Charme: base verniciata brun Sablè con piano Rosso Lepanto.  
 Kant sofa: cover art.1960/110, cat. EXTRALUX.  
 Decorative cushion: art.4263/18, cat. H and art.1900/05, cat. H.  
 Navona armchair: cover art.1940/21, cat. pelle accoppiata.  
 Charme coffee table: brun Sablè painted base with Red Lepanto.  
 Domino pouf Ø50x43h: cover art.4263/18, cat. H.

## Composizione pagina 16-17 / Layout page 16-17

Divano Kant: rivestimento art.1900/11, cat. H.  
 Cuscini decorativi art.1900/11, cat. H e pelle Seta impruneta, cat. pelle base fiore.  
 Tavolino Kant: rivestimento art.1900/11, cat. H. con piano in marmo Verde Guatemala.  
 Poltrona Navona: rivestimento art.1940/26, cat. pelle accoppiata.  
 Kant sofa: cover art.1900/11, cat. H. Decorative cushion: art.1900/11, cat. H and leather Seta col. impruneta cat. pelle base fiore.  
 Kant coffee table: cover art.1900/11, cat. H with green Guatemala marble top.  
 Navona armchair: cover art.1940/26, cat. pelle accoppiata.

## Composizione pagina 24-25 / Layout page 24-25

Divano Kant: rivestimento art.4264/66, cat. pelle accoppiata.  
 Cuscini decorativi art.4263/18, cat. H e art. 1930/17, cat. EXTRA.  
 Poltrona Jack: rivestimento art.1930/17, cat. EXTRA con struttura in Frassino tinto Noce scuro.  
 Tavolino Charme: base verniciata brun sablè con piano Rosso Lepanto.  
 Kant sofa: cover art.4264/66, cat. pelle accoppiata. Decorative cushion: art.4263/18, cat. H and art.1930/17, cat. EXTRA.  
 Jack armchair: cover art.1930/17, cat. EXTRA with structure in ash painted dark walnut.  
 Charme coffee table: base painted brun Sablè with red Lepanto marble top.

## Composizione pagina 28-29 / Layout page 28-29

Divano Kant: rivestimento art.1950/43, cat. EXTRALUX.  
 Cuscini decorativi art.1950/43, cat. EXTRALUX e art. 1910/08, cat. H.  
 Poltrona Navona: rivestimento art.1940/04, cat. pelle accoppiata.  
 Tavolino Tape: struttura in Frassino tinto nero con piano Bianco Carrara.  
 Kant sofa: cover art.1950/43, cat. EXTRALUX. Decorative cushion: art.1950/43, cat. EXTRALUX and art.1910/08, cat. H.  
 Navona armchair: cover art.1940/04, cat. pelle accoppiata.  
 Tape coffee table: structure in ash painted black with white Carrara marble top.

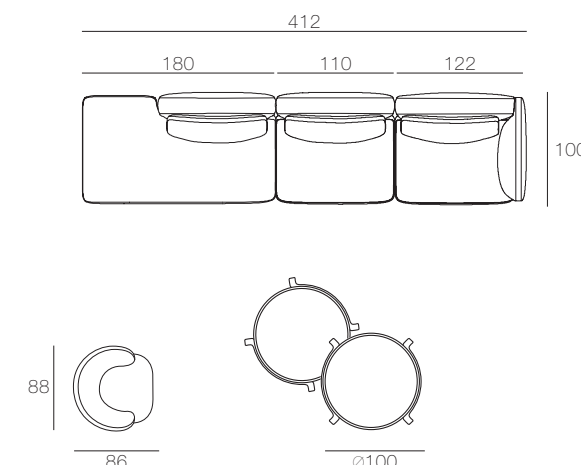
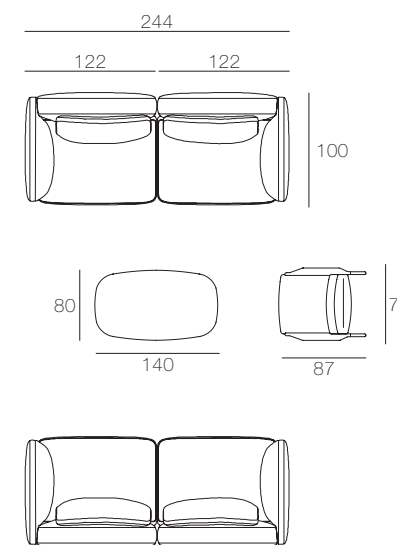
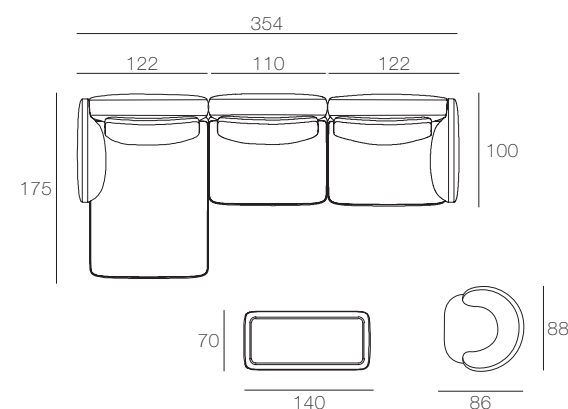
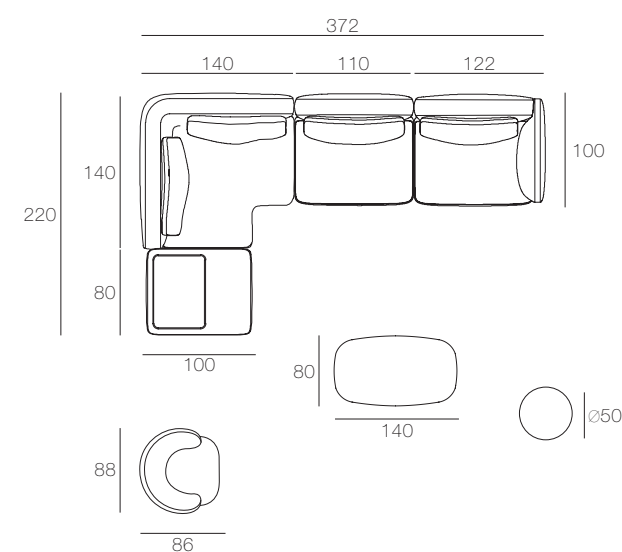

## Composizione pagina 20-21 / Layout page 20-21

Divano Kant: rivestimento art.1930/111, cat. EXTRA. Cuscini decorativi art.1930/111, cat. EXTRALUX e art. 1930/118, cat. EXTRA.  
 Tavolino Kant: rivestimento art.1930/111, cat. EXTRA con piano in Marmo Calacatta.  
 Poltrona Navona: rivestimento art.4264/19, cat. pelle accoppiata.  
 Pouff Domino Ø50x43h: rivestimento art.1930/118, cat. EXTRA.  
 Kant sofa: cover art.1930/111, cat. EXTRA. Decorative cushion: art.1930/111, cat. EXTRALUX and art.1930/118, cat. EXTRA.  
 Kant coffee table: cover art.1930/111, cat. EXTRA with Calacatta marble top.  
 Navona armchair: cover art.4264/19, cat. pelle accoppiata.  
 Domino pouf Ø50x43h: cover art.1930/118, cat. EXTRA.

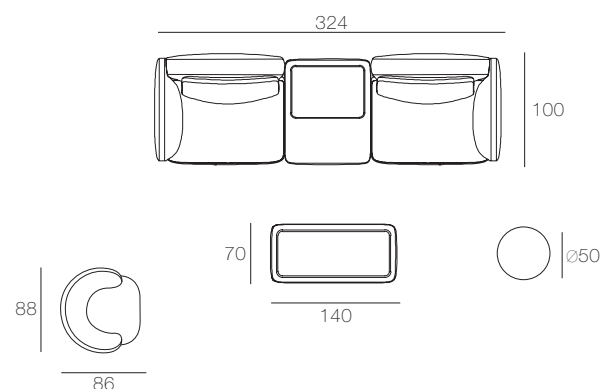



# BAGUTTA

Design Marconato&Zappa

**Struttura:** realizzata in legno di massello e multistrato. Il molleggio è ottenuto con cinghie elastiche larghezza mm 90, rivestita in poliuretano espanso densità differenziata 25P e 40P e tela di cotone 150 gr. con vellutino.

**Imbottitura:** cuscini seduta e schienale in poliuretano espanso densità differenziata 35KN 30S 40P 25S rivestiti con fibra di dacron 150 gr.

**Rivestimento:** tessuto completamente sfoderabile.

**Marmi per tavolino:** Emperador, Calacatta, Sahara Noir, Rosso Lepanto, Verde Guatemala, Bianco Carrara.

**Finiture:** piedini in abs nero.

**Frame:** made in fir wood and multi-ply panels. The support system is created using 90 mm wide interwoven elastic straps, covered in polyurethane differentiated densities 25P 40P and 150 gr. cotton cloth with velveteen.

**Padding:** seat cushions and back cushions in polyurethane foam with differentiated density 35KN 30S 40P 25S and 150 gr. cotton cloth with velveteen.

**Cover:** completely removable fabric.

**Marble for side table:** Emperador, Calacatta, Sahara Noir, Lepanto red, Guatemala green, Bianco Carrara.

**Finishes:** feet in black abs.

## VARIANTI PIANO IN MARMO MARBLE TOP OPTIONS

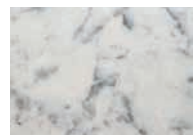

Bianco Carrara  
Carrara white



Calacatta  
Calacatta

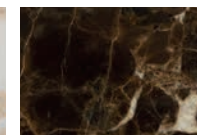

Emperador  
Emperador



Sahara Noir  
Sahara noir

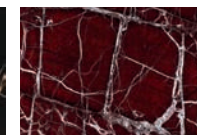

Rosso Lepanto  
Lepanto red



Verde Guatemala  
Guatemala green

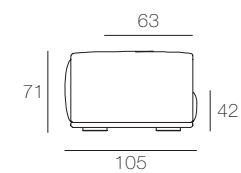

Divani\_Sofas

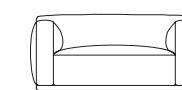

140

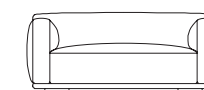

160

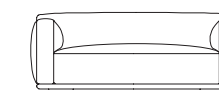

175

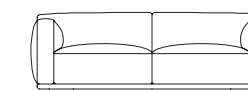

200

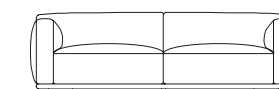

220

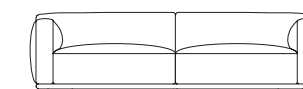

240

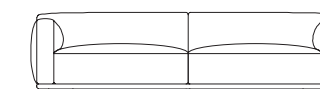

260

Divano bracciolo sx/dx\_Sofas with 1 arm left/right

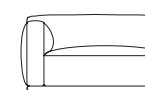

120

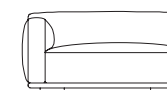

130

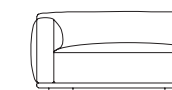

140

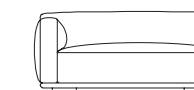

155

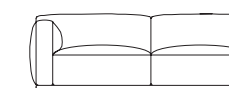

180



200



220

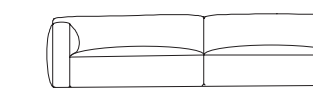

240

Elemento centrale divano\_Central element for sofa

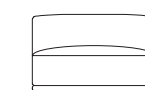

100

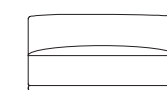

120

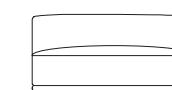

135

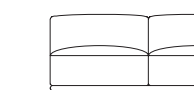

160

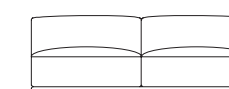

180

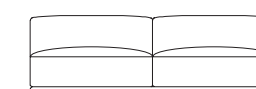

200



220

Cuscino\_Cushion

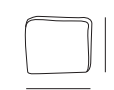

55

Elemento centrale tondo  
Round central element

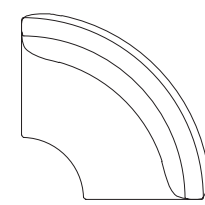

154

Angolo retto  
Right corner

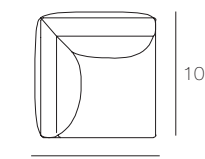

105

Pouff\_Pouf

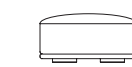

80

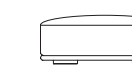

105



80

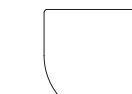

90

Elemento tavolino\_Element side table



100

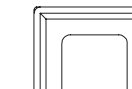

105



105



67

Chaise longue sx/dx\_Chaise longue left/right

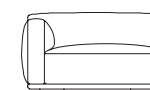

120

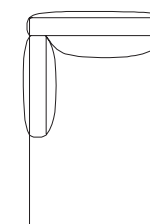

180

Elemento penisola sx/dx  
Peninsula left/right

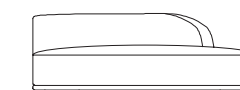

185

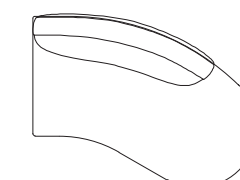

150

Elemento panca\_Element bench

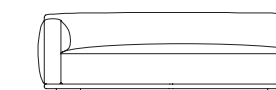

220

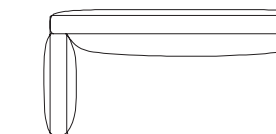

105

Elemento centrale inclinato  
Inclined central element

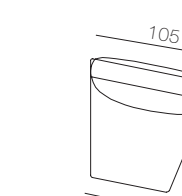

70



# BAGUTTA

Design Marconato&Zappa

## Composizione pagina 34-35 / Layout page 34-35

**Divano Bagutta:** rivestimento tessuto art.1870/01, cat. EXTRA.  
Cuscini decorativi art.1870/08, cat. EXTRA. Tavolino con piano marmo Calacatta.  
**Poltrona Guest:** rivestimento tessuto art.4263/26, cat. H.  
Struttura in Frassino tinto Wengè.  
**Tavolino Tape Ø100x40h:** struttura Frassino tinto nero con piano marmo Sahara Noir.  
**Tavolino Tape Ø100x32h:** struttura Frassino tinto nero con piano marmo Calacatta.  
**Bagutta sofa:** cover art.1870/01, cat. EXTRA. Decorative cushion: art.1870/08, cat. EXTRA. Coffee table in Calacatta marble top.  
**Guest armchair:** cover art.4263/26, cat. H. Structure ash painted Wengè.  
**Tape coffee table Ø100x40h:** structure ash painted black with Sahara Noir marble top.  
**Tape coffee table Ø100x32h:** structure ash painted black with Calacatta marble top.

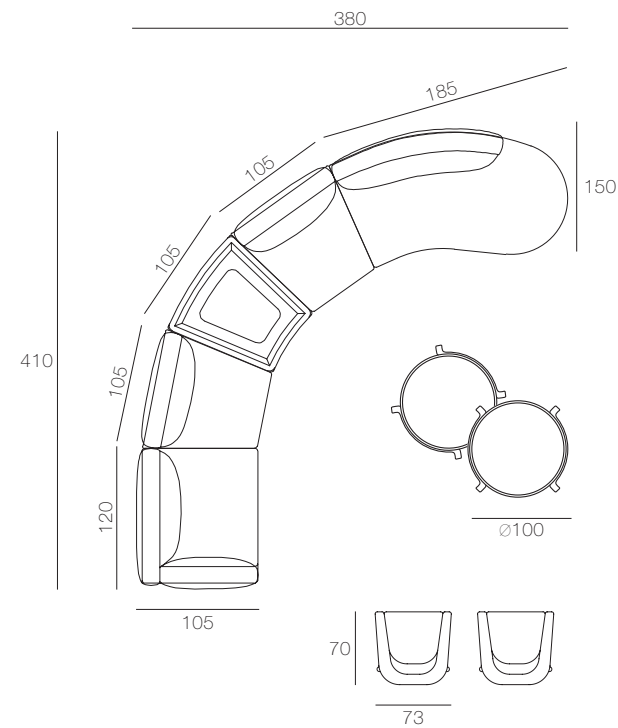

## Composizione pagina 38-39 / Layout page 38-39

**Divano Bagutta:** rivestimento tessuto art.1870/08, cat. EXTRA.  
Cuscini decorativi art.1870/01, cat. EXTRA. Tavolino con piano marmo Sahara Noir, struttura frassino tinto Wengè.  
**Poltrona Guest:** rivestimento tessuto art.4263/26, cat. H.  
Struttura in Frassino tinto Wengè.  
**Tavolino Tape Ø100x40h:** struttura Frassino tinto Wengè con piano marmo Sahara Noir.  
**Tavolino Tape Ø100x32h:** struttura Frassino tinto Wengè con piano marmo Calacatta.  
**Bagutta sofa:** cover art.1870/08, cat. EXTRA. Decorative cushion: art.1870/01, cat. EXTRA. Coffee table in Sahara Noir marble top and ash painted Wengè structure.  
**Guest armchair:** cover art.4263/26, cat. H. Structure ash painted Wengè.  
**Tape coffee table Ø100x40h:** ash painted Wengè structure with Sahara Noir marble top.  
**Tape coffee table Ø100x32h:** ash painted Wengè with Calacatta marble top.

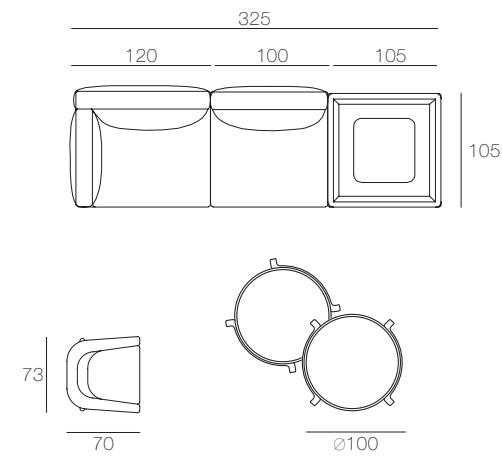

## Composizione pagina 42-43 / Layout page 42-43

**Divano Bagutta:** rivestimento art.1850/01, cat. VIP.  
Cuscini decorativi art.1850/06, cat. VIP.  
**Poltrona Margot:** rivestimento art.1850/06, cat. VIP. Struttura Frassino tinto nero.  
**Tavolino Tape Ø62x55h:** struttura Frassino tinto nero con piano in marmo Sahara Noir.  
**Pouff Tresor 45x45x41h:** rivestimento art.4263/26, cat. H.  
**Bagutta sofa:** cover art.1850/01, cat. VIP. Decorative cushion: art.1850/06, cat. VIP.  
**Margot armchair:** cover art.1850/06, cat. VIP. Ash painted black structure.  
**Tape coffee table Ø62x55h:** ash painted black structure with Sahara Noir marble top.  
**Tresor pouf 45x45x41h:** cover art.4263/26, cat. H.

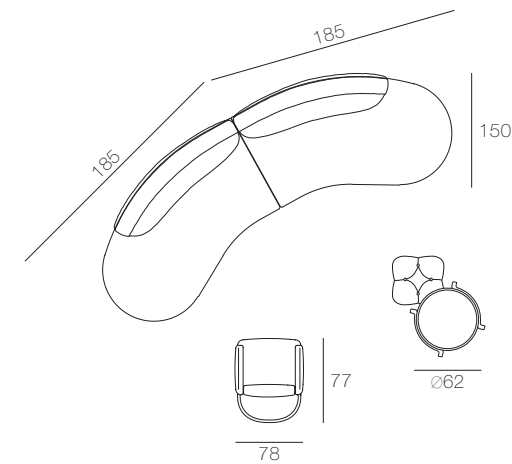

## Composizione pagina 46-47 / Layout page 46-47

**Divano Bagutta:** rivestimento art.4264/12, cat. pelle accoppiata.  
Cuscini decorativi art.1910/15, cat. EXTRA.  
**Poltrona Jack:** rivestimento art.1910/15, cat. EXTRA.  
Struttura in Frassino tinto Noce.  
**Pouff Domino Ø50x62h:** rivestimento art.4263/26, cat. H. Piano in marmo Sahara Noir.  
**Pouff Brera 50x50x34h:** rivestimento art.4263/26, cat. H.  
**Bagutta sofa:** cover art.4264/12, cat. pelle accoppiata. Decorative cushion: art.1910/15, cat. EXTRA.  
**Jack armchair:** cover art.1910/15, cat. EXTRA and ash painted walnut structure.  
**Domino pouf Ø50x62h:** cover art.4263/26, cat. H with Sahara Noir marble top.  
**Brera pouf 50x50x34h:** cover art.4263/26, cat. H.

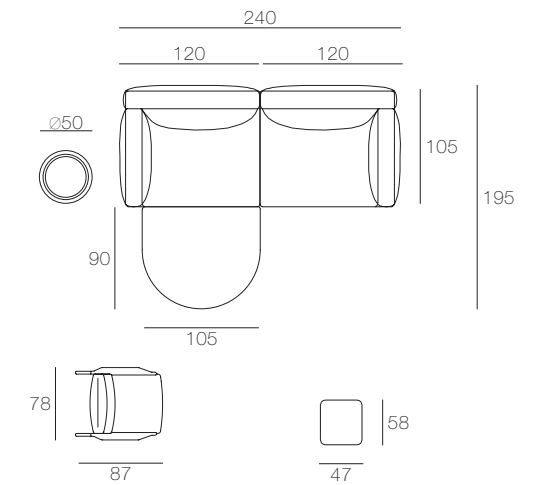



# NAVONA

Design Marconato&Zappa

**Struttura:** realizzata con pannelli in legno multistrato curvato. Il molleggio è ottenuto con cinghie elastiche larghezza mm 90 rivestita in poliuretano espanso densità differenziata 25P e 40P e tela di cotone 150gr. con vellutino.

**Imbottitura:** cuscino di seduta in poliuretano espanso a densità differenziata 35KN 30S 40P e 25S rivestiti con fibra di dacron 150gr e vellutino.

**Rivestimento:** tessuto sfoderabile solo seduta.

**Finiture:** basamento girevole o piedini in abs nero.

**Frame:** bent multi-ply. The support system is created using 90 mm wide interwoven elastic straps, covered in differentiated density polyurethane foam 25P 40P and 150gr cotton cloth with velveeten.

**Padding:** seat cushions in differentiated density polyurethane foam 35KN 30S 40P and 25S and 150gr cotton cloth with velveeten.

**Cover:** removable only seat cushion.

**Base:** swivel base or feet in black abs.

## CON BASAMENTO - WITH BASE

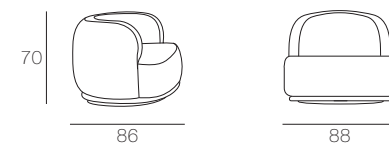

## CON PIEDINI - WITH FEET

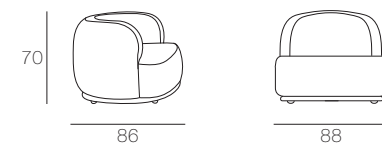

### Composizione pagina 48 / Layout page 48

Poltrona Navona: rivestimento art.1940/21, cat. pelle accoppiata.  
Navona armchair: cover art.1940/21, cat. pelle accoppiata.

### Composizione pagina 48 / Layout page 48

Poltrona Navona: rivestimento art.1940/26, cat. pelle accoppiata.  
Navona armchair: cover art.1940/26, cat. pelle accoppiata.

### Composizione pagina 48-49/ Layout page 48-49

Poltrona Navona: rivestimento art.1940/04, cat. pelle accoppiata.  
Navona armchair: cover art.1940/04, cat. pelle accoppiata.

### VARIANTI PIEDINI IN ABS ABS FEET OPTIONS



Verniciato Nero  
Black painting

# MARGOT

Design Marconato&Zappa

**Struttura:** realizzata in legno di Abete e pannelli in legno multistrato curvato. Molleggio ottenuto con cinghie elastiche Intes Elabelt 790/4 larghezza mm 90.

**Schienale e sedile:** in poliuretano espanso a densità differenziata T30 e T40. Poliuretano a densità differenziata T21 SM e T40 P. Resinato 100gr. accoppiato con vellutino. Cuscino poggiatesta T25 rivestito in fodera di cotone.

**Rivestimento:** tessuto completamente sfoderabile.

**Basamento:** la poltrona è disponibile in due versioni, con basamento o con piedini. I piedini in metallo disponibile nelle seguenti finiture: verniciato Oro, Brun Sablè, Nero, Grigio. Basamento in Frassino naturale o tinto Wengè, Noce, Noce scuro, laccato a poro aperto Bianco, e laccato a poro aperto Nero.

**Frame:** Fir wood and bent multi-ply panels. Elastic webbing suspension (90mm wide, Intes Elabelt 790/4).

**Backrest and seat:** seat in differentiated density polyurethane foam (T30 and T40). Differentiated density polyurethane foam (T21 SM and T40 P). Resin (100gr) coupled with velveeten. Lower back cushion (T25) covered with cotton lining.

**Cover:** fully removable fabric.

**Base:** the sofa comes in two versions, with base or with feet. Aluminium feet available in the following finishes: painted in satin Gold, Brun Sablè, Black and Grey. Base in Ash wood – Natural or Wengè, Walnut, dark Walnut stain and with white or Black open-pore lacquered.

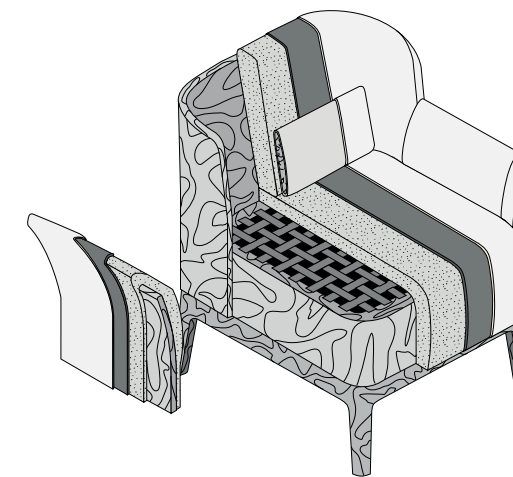

## CON PIEDINI - WITH FEET

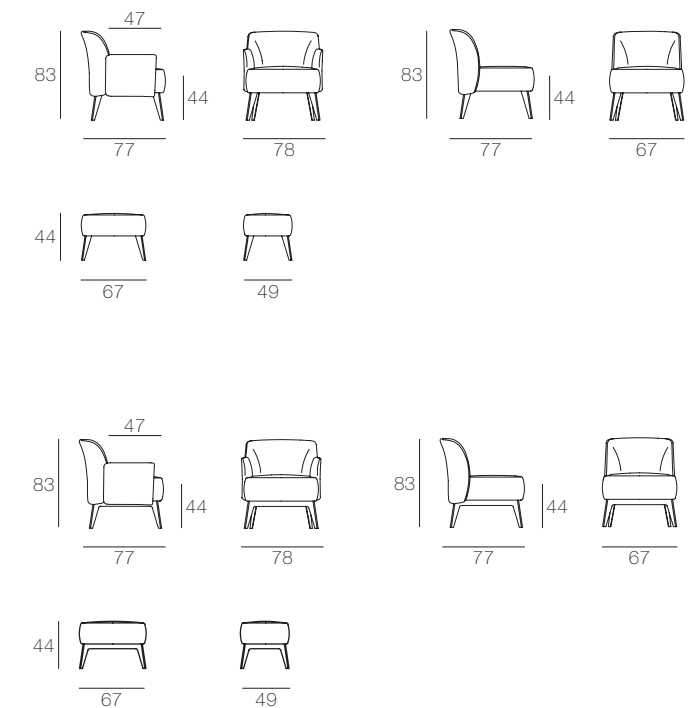

### VARIANTI BASAMENTO IN LEGNO WOODEN BASE OPTIONS

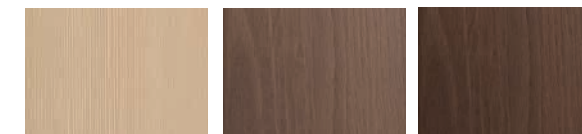

Frassino Naturale  
Natural Ash

Frassino tinto Noce  
Walnut stained Ash

Frassino tinto scuro  
Dark stained Ash

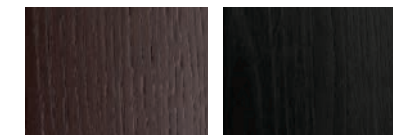

Frassino Wengè  
Wengè Ash

Frassino tinto nero  
Black stained Ash



Frassino laccato  
Nero poro aperto  
Open-pore Black Ash

Frassino laccato  
Bianco poro aperto  
Open-pore white Ash

### VARIANTI PIEDINI IN METALLO ALUMINIUM FEET OPTIONS



Verniciato Oro  
Gold painting

Verniciato Brun Sablè  
Brun Sablè painting

Verniciato Nero  
Black painting

Verniciato Grigio  
Grey painting



# JACK

Design Marconato&Zappa

**Struttura:** realizzata in legno massello di Frassino tinto o Noce Canaletto.  
**Finitura struttura:** in legno Frassino tinto o laccato nei colori disponibili o Noce Canaletto.  
**Schienale e sedile:** in poliuretano espanso a densità differenziata T40 e T25 rivestiti con resinato 150gr/mq accoppiato con vellutino con inserto in multistrato.  
**Rivestimento:** in pelle, Nabuk o tessuto non sfoderabile.

**Frame:** stained solid Ash or Canaletto Walnut.  
**Frame finish:** stained or lacquered Ash wood in the available colours or Canaletto Walnut.  
**Backrest and seat:** T40 and T25 differentiated density polyurethane foam covered with 150gr/m2 resin coupled with velveteen with multi-ply insert.  
**Cover:** not removable leather, Nubuck or fabric.

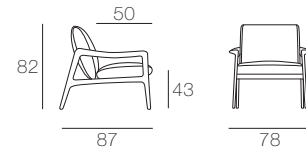

## VARIANTI BASAMENTO IN LEGNO WOODEN BASE OPTIONS



Frassino Naturale Natural Ash  
Frassino tinto Noce Walnut stained Ash  
Frassino tinto scuro Dark stained Ash  
Frassino tinto Wengè Wengè stained Ash  
Frassino tinto nero Black stained Ash  
Frassino laccato Nero poro aperto Open-pore Black Ash  
Frassino laccato Bianco poro aperto Open-pore white Ash

# GUEST

Design Marconato&Zappa

**Struttura:** realizzata in legno massello e multistrato curvato.  
**Rivestimento struttura:** in legno Frassino tinto nei colori disponibili o Noce Canaletto.  
**Imbottitura:** in poliuretano a densità differenziata T35 e T40 e rivestiti con resinato 150gr./mq accoppiato con vellutino.  
**Rivestimento:** in pelle, Nabuk o tessuto, non sfoderabile.

**Frame:** stained solid Ash or Canaletto Walnut and bent multi-ply.  
**Frame finish:** stained or lacquered Ash wood in the available colours or Canaletto Walnut.  
**Backrest and seat:** T35 and T40 differentiated density polyurethane foam covered with 150gr/m2 resin coupled with velveteen.  
**Cover:** not removable leather, Nubuck or fabric.

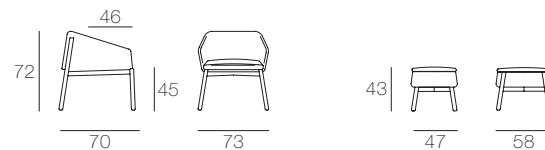

## VARIANTI BASAMENTO IN LEGNO WOODEN BASE OPTIONS



Frassino Naturale Natural Ash  
Frassino tinto Noce Walnut stained Ash  
Frassino tinto scuro Dark stained Ash  
Frassino tinto Wengè Wengè stained Ash  
Frassino tinto nero Black stained Ash  
Frassino laccato Nero poro aperto Open-pore Black Ash  
Frassino laccato Bianco poro aperto Open-pore white Ash

# KANT

Design Marconato&Zappa

**Struttura:** realizzata in legno massello e multistrato.  
**Imbottitura:** in poliuretano espanso a densità differenziate 35KN 30S rivestiti con fibra di dacron 150gr.  
**Rivestimento:** tessuto completamente sfoderabile.  
**Marmi per piano:** Emperador, Calacatta, Sahara Noir, Rosso Lepanto, Verde Guatemala, Bianco Carrara.  
**Finiture:** piedini in abs nero.

**Frame:** made in fir wood and multi-ply panels.  
**Padding:** in polyurethane foam with differentiated density 35KN 30S and 150 gr. cotton cloth with velveteen.  
**Cover:** completely removable fabric.  
**Marble for side table:** Emperador, Calacatta, Sahara Noir, Lepanto red, Guatemala green, Bianco Carrara.  
**Finishes:** feet in black abs.

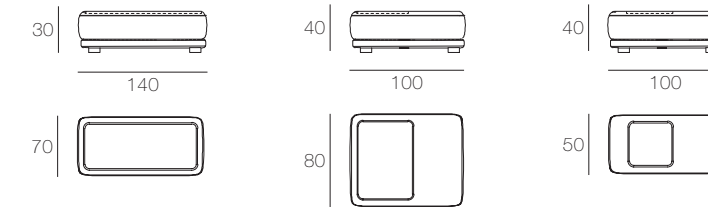

## Composizione pagina 50-51 / Layout page 50-51

Tavolino Kant: rivestimento art.1960/110, cat. EXTRALUX. Piano in verde Guatemala.  
Kant coffee table: cover art.1960/110, cat. EXTRALUX. Top in Guatemala green marble.

## VARIANTI PIEDINI IN ABS ABS FEET OPTIONS



Verniciato Nero  
Black painting

## VARIANTI PIANO IN MARMO MARBLE TOP OPTIONS

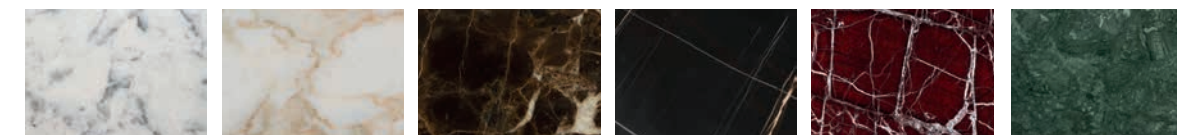

Bianco Carrara Carrara white  
Calacatta Calacatta  
Emperador Emperador  
Sahara Noir Sahara noir  
Rosso Lepanto Lepanto red  
Verde Guatemala Guatemala green



# CHARME

Design Marconato&Zappa

**Struttura:** realizzata in metallo in due finiture: verniciato bronzo scuro anodizzato e verniciato Oro.

**Piano superiore:** disponibile in marmo Emperador, Calacatta, Sahara Noir, Rosso Lepanto, Verde Guatemala e Bianco Carrara.

**Frame:** metal base in two finishes - painted dark bronze anodized and painted Gold satin finish.

**Upper top:** available in Emperador, Calacatta, Sahara Noir, Lepanto red, Guatemala green and Bianco Carrara marble.

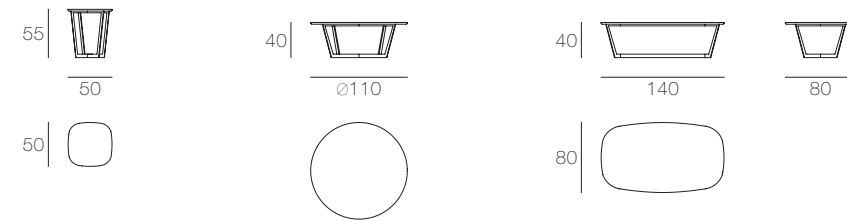

## VARIANTI BASAMENTO BASE OPTIONS



Verniciato bronzo scuro anodizzato  
Anodized dark bronze paint

Verniciato Oro  
Gold painted

## VARIANTI PIANO IN MARMO MARBLE TOP OPTIONS

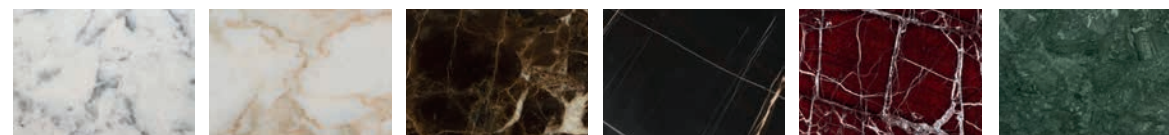

Bianco Carrara  
Carrara white

Calacatta  
Calacatta

Emperador  
Emperador

Sahara Noir  
Sahara noir

Rosso Lepanto  
Lepanto red

Verde Guatemala  
Guatemala green

# TAPE

Design Marconato&Zappa

**Struttura:** realizzata in legno massello curvato di Frassino tinto nei colori disponibili o Noce Canaletto.

**Piano:** disponibile in marmo Emperador, Calacatta, Sahara Noir, Rosso Lepanto, Verde Guatemala, Bianco Carrara od in gres porcellanato finitura Calacatta o nero Marquinia.

**Frame:** curved solid Ash wood stained in the available colours or Canaletto Walnut.

**Top:** available in Emperador, Calacatta, Sahara Noir, Lepanto red, Guatemala green, Bianco Carrara marble or in porcelain stoneware with Calacatta or Marquinia black finish.

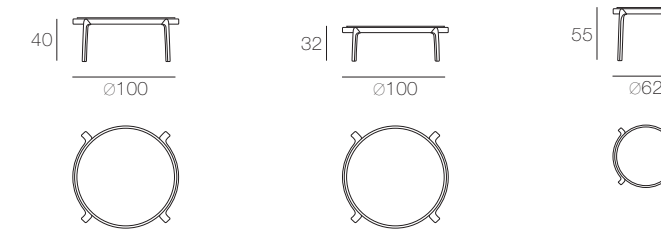

## VARIANTI BASAMENTO IN LEGNO WOODEN BASE OPTIONS



Frassino Naturale  
Natural Ash

Frassino tinto Noce  
Walnut stained Ash

Frassino tinto scuro  
Dark stained Ash

Frassino tinto Wengè  
Wengè stained Ash

Frassino tinto nero  
Black stained Ash

Frassino laccato  
Nero poro aperto  
Open-pore Black Ash

Frassino laccato  
Bianco poro aperto  
Open-pore white Ash

## VARIANTI PIANO IN GRES PORCELLANATO PORCELAIN STONEWARE TOP OPTIONS

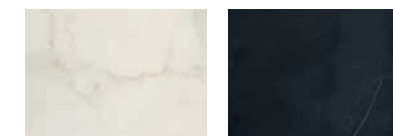

Calacatta  
Calacatta

Nero Marquinia  
Marquinia black

## VARIANTI PIANO IN MARMO MARBLE TOP OPTIONS

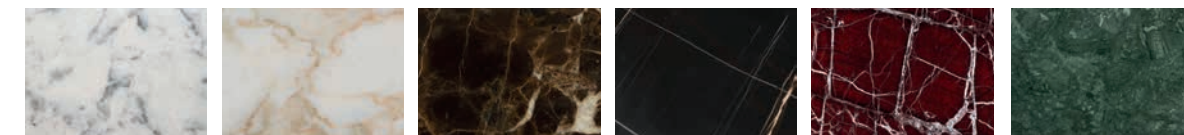

Bianco Carrara  
Carrara white

Calacatta  
Calacatta

Emperador  
Emperador

Sahara Noir  
Sahara noir

Rosso Lepanto  
Lepanto red

Verde Guatemala  
Guatemala green



# DOMINO

Design UT. CTS salotti

**Struttura:** realizzata in multistrato di Abete.

**Imbottitura:** in poliuretano espanso.

**Rivestimento:** in pelle, Nabuk o tessuto non sfoderabile.

Il pouff domino è disponibile in quattro versioni con e senza basamento e con piano superiore o senza.

**Basamento:** realizzato in legno Faggio tinto o laccato nei colori disponibili.

**Piano superiore:** realizzato in gres porcellanato finitura Calacatta o Nero Marquinia.

**Frame:** fir multi-ply.

**Padding:** polyurethane foam

**Cover:** not removable leather, Nubuck or fabric.

The domino pouf is available in four versions with and without base and with or without top.

**Base:** stained or lacquered beech wood in the available colours.

**Upper top:** available in Calacatta or Marquinia Black porcelain stoneware.

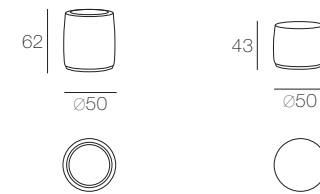
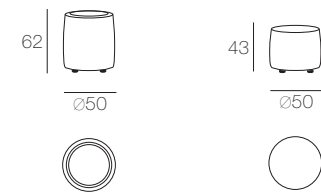

## VARIANTI PIANO IN GRES PORCELLANATO PORCELAIN STONEWARE TOP OPTIONS



Calacatta  
Calacatta

Nero Marquinia  
Marquinia black

## VARIANTI PIANO IN MARMO MARBLE TOP OPTIONS

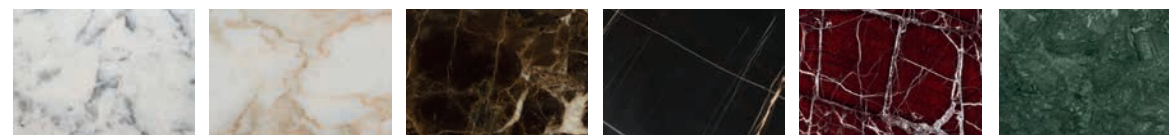

Bianco Carrara  
Carrara white

Calacatta  
Calacatta

Emperador  
Emperador

Sahara Noir  
Sahara noir

Rosso Lepanto  
Lepanto red

Verde Guatemala  
Guatemala green

# TRESOR

Design UT. CTS salotti

**Struttura:** realizzata in multistrato di Abete.

**Imbottitura:** in poliuretano espanso con lavorazione a capitonnè.

**Rivestimento:** in pelle, Nabuk o tessuto.

**Finiture:** piedini in abs Nero.

**Frame:** fir multi-ply.

**Padding:** polyurethane foam with button-tufting.

**Cover:** leather, Nubuck or fabric.

**Finishes:** feet in Black abs.

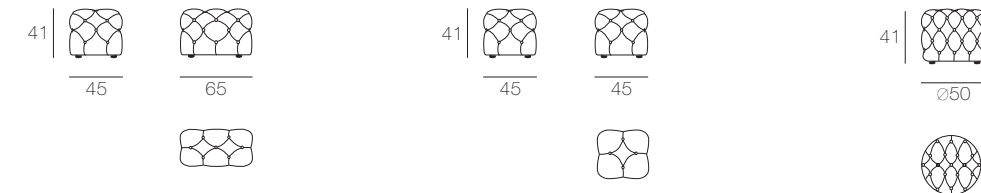

## VARIANTI PIEDINI IN ABS ABS FEET OPTIONS



Verniciato Nero  
Black painting

# BRERA

Design UT. CTS salotti

**Struttura:** realizzata in multistrato di Abete.

**Imbottitura:** in poliuretano espanso a densità differenziate PF 30 e T 40 e tela di cotone 150 gr con vellutino.

**Rivestimento:** in pelle o in tessuto sfoderabile.

**Finiture:** piedini in abs Nero.

**Frame:** multi-ply Fir.

**Padding:** in polyurethane foam with differentiated densities PF 30 and T 40 and 150 gr cotton cloth with velveteen.

**Cover:** leather or removable fabric.

**Finishes:** feet in Black abs.

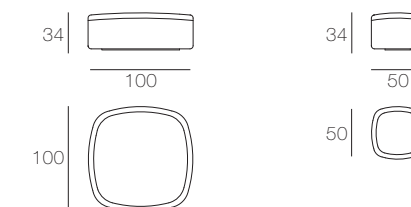

## VARIANTI PIEDINI IN ABS ABS FEET OPTIONS



Verniciato Nero  
Black painting



**Credits:**

AD: Galvani&Tremolada

Data la nostra politica aziendale di continua implementazione e miglioramento dei nostri prodotti, le dimensioni e le caratteristiche tecniche degli stessi potrebbero variare in qualsiasi momento, secondo le esigenze tecnico e commerciali, e ciò senza l'obbligo di preavviso e senza possibilità di rivendicazione da parte dell'acquirente.

Le illustrazioni, i dati e le descrizioni contenuti in questo catalogo non sono quindi impegnativi ed hanno solo valore indicativo.

La tecnica di stampa può determinare differenze di colore. Per una corretta valutazione di tonalità e colore è necessario fare riferimento ai campioni fisici. In ogni caso, i materiali quali metalli, tessuti, pelli, marmi ed essenze possono essere oggetto di naturali ed inevitabili differenze di tonalità e di venatura rispetto al campione fisico.

Nessuna parte di questo catalogo, testo o fotografia può essere riprodotta o trasmessa in qualsiasi forma o tramite mezzo elettronico o meccanico, comprese le fotocopie, senza previo permesso scritto da parte della società CTS SALOTTI.

*Due to the company policy of continuous implementation and improvement of our product, dimensions and technical characteristics may vary at any time, according to technical and commercial requirements. These variations may occur without obligation of warning and without the possibility of claim by the buyer. The illustrations, data and descriptions contained in this catalogue are therefore to be considered as an indication of the final products.*

*Printing methods can determine colour differences. For a correct evaluation of tone and colour it is necessary to refer to the physical samples. In any case, materials such as metal, fabrics, leather, marble and wood may be subject to natural and inevitable differences in tone and grain compared to the physical sample.*

*No part of this catalogue, text or photograph may be reproduced or transmitted in any shape or form, through electronic or paper-based communication, including photocopies, without the prior express written consent of CTS SALOTTI.*

**CTS**  
**ITALIAN SOFAS**

Via Ada Negri, 5\_Carate Brianza (MB)  
Italy +39 0362 991038  
info@ctssalotti.com\_www.ctssalotti.com



